

## LI72720T041TA3598

4.12 inch, 720\*720 pixels resolution, MIPI interface, IPS-TFT-LCD



Disclaimer: The product design is subject to alternation and improvement without prior notice.

## Table of Contents

1 General Feature.....	3
2 Mechanical Drawing.....	4
3 Input/Output Terminals.....	5
4 Electrical Characteristics.....	6
5 Timing Characteristics.....	7
6 Optical Characteristics.....	14
7 Environmental Reliability Test.....	17
8 Packing Capacity & Dimension.....	18
9 Appearance Inspection.....	19
10 Precautions for Use of LCD Modules.....	22
11 LCD Introduction.....	23

## 1 General Feature

Feature		Description	Unit
Display Spec.	Size	4.12	inch
	Resolution	720(H)*720(V)	pixels
	Pixel Configuration	RGB stripe	-
	Pixel Pitch	0.10275(W)*0.10275(H)	mm
	Viewing Direction	ALL	-
Mechanical Characteristics	Outside Dimension	77.98(W)*82.00(H)*2.13(D)	mm
	Active Area	73.98(W)*73.98(H)	mm
	Luminance	350	cd/m <sup>2</sup>
	CTP Touch Method	Finger	-
	Number of Simultaneous Touches	2	-
	Minimum Touch Area	Φ7	
	CTP Structure	Incell(Without Cover Lens)	-
	LED Numbers	12 LEDS	-
	Pin Order	From left to right 40PIN_0.5mm	-
	With /Without TSP	With TSP	-
	Matching Connection Type	FH34SRJ-40S-0.5SH(50)	-
Electrical Characteristics	Interface	MIPI	-
	CTP Interface	IIC	-
	Color Depth	16.7M	colors
	Driver Condition	-	V
	Driver IC	ILI2882N	-
Temperature Range	Operating Temp.	-20~70	°C
	Storage Temp.	-30~80	°C

**Note: Requirements on Environmental Protection: RoHS. You can use dynamic screen saver wallpapers to avoid afterimages caused by fixed paper display for a long time**



### 3 Input/Output Terminals

Pin NO.	Symbol	Function	Remark
1	LEDK	LED cathode pin	
2	LEDA	LED anode pin	
3	NC	Not connect	
4	GND	Power Ground	
5	D2P	MIPI DSI DATA2 Positive	
6	D2N	MIPI DSI DATA2 Negative	
7	GND	Power Ground	
8	D1P	MIPI DSI DATA1 Positive	
9	D1N	MIPI DSI DATA1 Negative	
10	GND	Power Ground	
11	CLKP	MIPI DSI CLOCK Positive	
12	CLKN	MIPI DSI CLOCK Negative	
13	GND	Power Ground	
14	D0P	MIPI DSI DATA0 Positive	
15	D0N	MIPI DSI DATA0 Negative	
16	GND	Power Ground	
17	D3P	MIPI DSI DATA3 Positive	
18	D3N	MIPI DSI DATA3 Negative	
19	GND	Power Ground	
20	NC	Not connect	
21	IOVCC	Power supply to interface pins(1.8V)	
22	AVDD	Positive input analog power for driver IC use(6.0V)	
23	NC	Not connect	
24	AVEE	Negative input analog power for driver IC use(-6.0V)	
25	VCCB	Power supply to level shift IC(3.3V). If not used, please let it open.	
26	NC	Not connect	
27	GND	Power Ground	
28	NC	Not connect	
29	TE	Tearing effect output signal. If not used, please let this pin open.	
30	RESET	LCM Reset pin, the LCD driver is initialized when RESET active low.	
31	NC	Not connect	
32	GND	Power Ground	
33	TP_RESET	Reset pin, the TP is initialized when RESET active low.	
34	GND	Power Ground	
35	TP_INT	Communication interrupt	
36	GND	Power Ground	
37	TP_SDA	I2C data	
38	TP_SCL	I2C clock	
39	GND	Power Ground	
40	GND	Power Ground	

## 4 Electrical Characteristics

### 4.1 Driving TFT LCD Panel

Item	Symbol	Min.	Typ.	Max.	Unit	Remark
Logic Operating Voltage	IOVCC	1.7	1.8	1.9	V	
Current of IOVCC	IIOVCC	-	25	33	mA	
Operating Voltage	AVDD	5.9	6.0	6.1	V	
Current of AVDD	IAVDD	-	8	13	mA	
Operating Voltage	AVEE	-6.1	-6.0	-5.9	V	
Current of AVEE	IAVEE	-	12	20	mA	
Operating Voltage	VCCB	3.2	3.3	3.4	V	
Input Logic High Voltage	VIH	0.7* IOVCC	-	IOVCC	V	IOVCC=1.8V
Input Logic Low Voltage	VIL	0	-	0.3* IOVCC	V	IOVCC=1.8V
Output Logic High Voltage	VOH	0.8* IOVCC	-	IOVCC	V	IOH=-1.0mA
Output Logic Low Voltage	VOL	0	-	0.2* IOVCC	V	IOL=+1.0mA

### 4.2 LED Backlight Specification

Item	Symbol	Min.	Typ.	Max.	Unit	Remark
Forward Voltage	$V_F$	-	9.8	11.05	V	
Forward Current	$I_F$	-	80	100	mA	
Luminance(with LCD)	$L_v$	300	350	-	cd/m <sup>2</sup>	
Uniformity(with L/G)	Avg	70	80	-	%	
LED Life-Time	Hr	20000	30000	-	Hour	

Note: 12LEDs (3LEDs Serial,4ways Parallel)

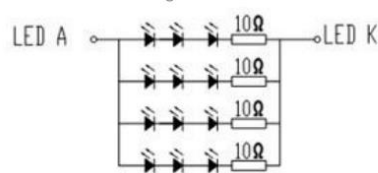

LED circuit

## 5 Timing Characteristics

### 5.1 Power on/off Sequence

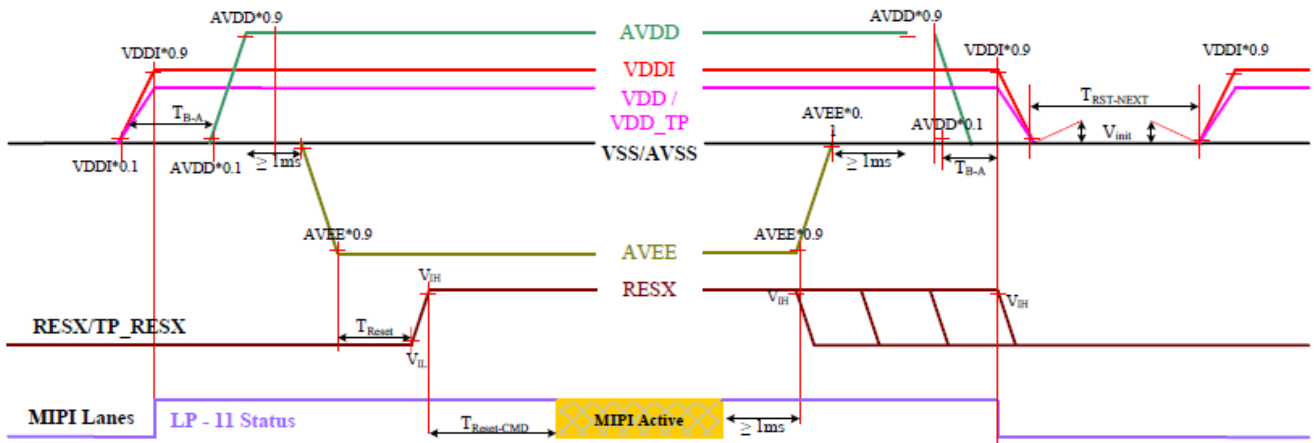

Power on/off Sequence

Symbol	Characteristics	Min.	Typ.	Max.	Units
$T_{Rise1}$	IOVCC Rise Time	0.1	-	20	ms
$T_{Rise2}$	AVDD/AVEE Rise Time	0.2	-	20	ms
$T_{Fall}$	External Power Fall Time	0.2	-	20	ms
$T_{B-A}$	Delay Time between Two External Power	2	5	-	ms
$T_{Reset}$	Delay Time between External Power and Reset	4	10	-	ms
$T_{Reset-CMD}$	Reset to First Command in Display Sleep In Mode	10	-	-	ms
$V_{init}$	Initialize Voltage			100	mV

Timing Relation of Power on/off Sequence

### 5.2 DSI Timing Characteristics

#### 5.2.1 High Speed Mode-Clock Channel Timing

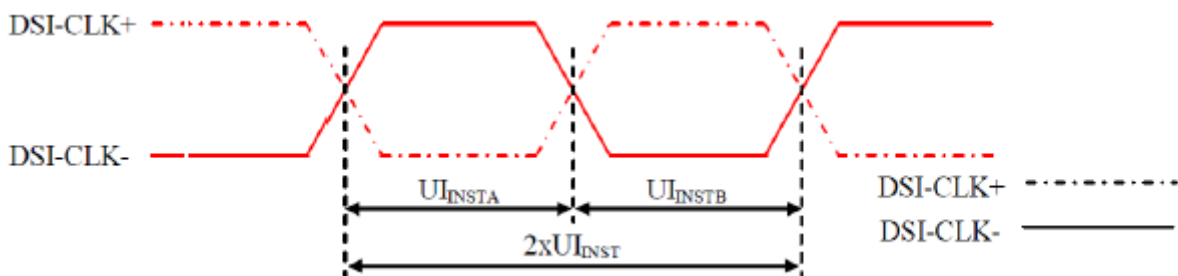

DSI Clock Channel Timing

Signal	Symbol	Parameter	Min.	Max.	Unit
DSI-CLK+/-	$2xUI_{INST}$	Double UI instantaneous	2	25	ns
DSI-CLK+/-	$UI_{INSTA}, UI_{INSTB}$	UI instantaneous Half	1	12.5	ns

DSI Clock Channel Timing

### 5.2.2 High Speed Mode-Data Clock Channel Timing

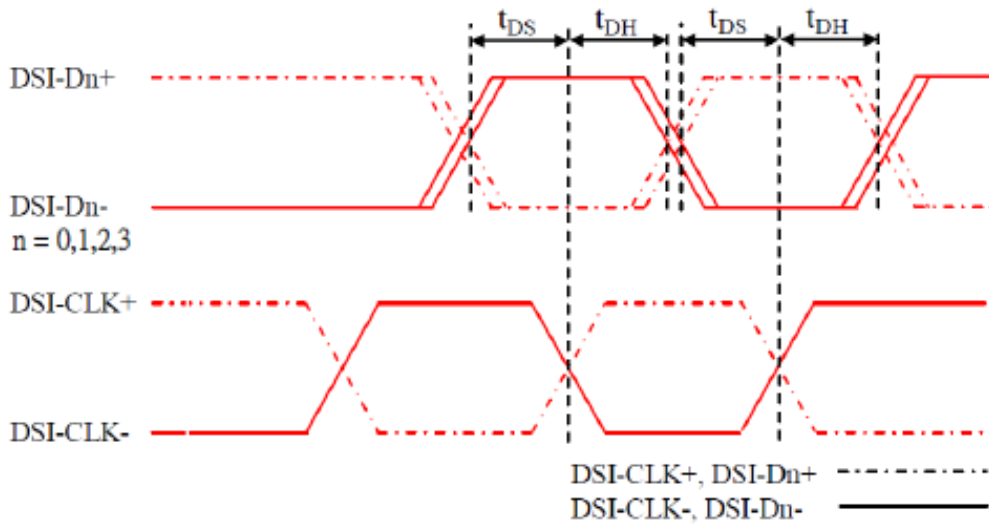

DSI Data to Clock Channel Timings

Signal	Symbol	Parameter	Min.	Max.
DSI-Dn+/- (n=0,1,2,3)	$t_{DS}$	Data to Clock Setup time	0.15xUI	-
	$t_{DH}$	Clock to Data Hold Time	0.15xUI	-

DSI Data to Clock Channel Timings

### 5.2.3 High Speed Mode-Rise and Fall Timings

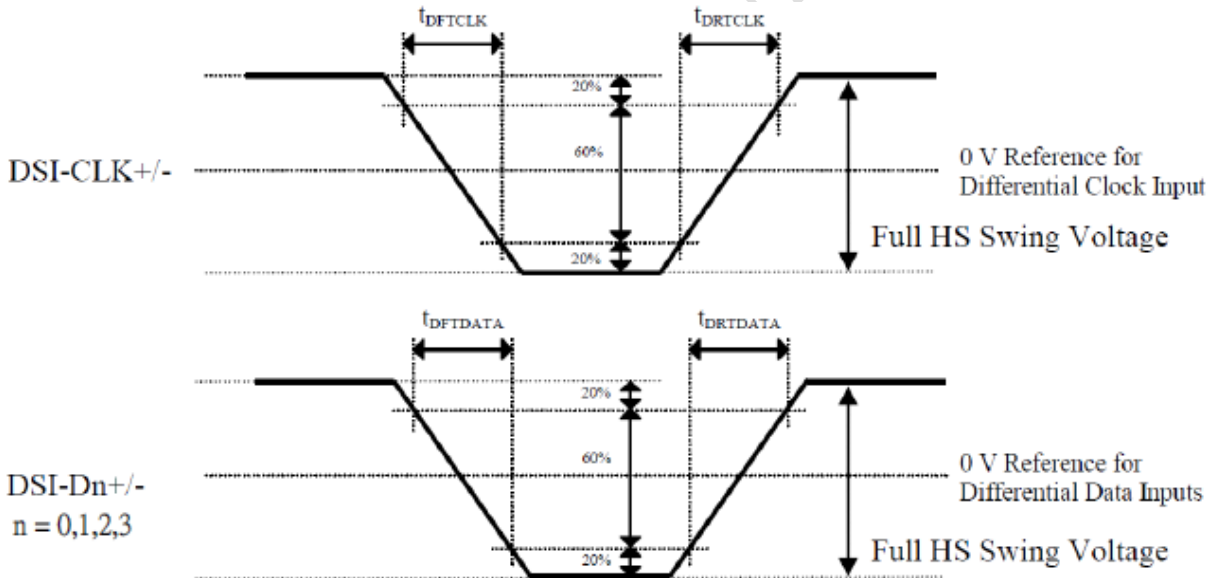

Rise and Fall Timings on Clock and Data Channels

Parameter	Symbol	Condition	Specification		
			Min.	Typ.	Max.
Differential Rise Time for Clock	$t_{DRTCLK}$	DSI-CLK+/-	150 ps	-	0.3UI
Differential Rise Time for Data	$t_{DRTDATA}$	DSI-Dn+/- (n=0,1,2,3)	150 ps	-	0.3UI
Differential Fall Time for Clock	$t_{DFTCLK}$	DSI-CLK+/-	150 ps	-	0.3UI
Differential Fall Time for Data	$t_{DFTDATA}$	DSI-Dn+/- (n=0,1,2,3)	150 ps	-	0.3UI

Rise and Fall Timings on Clock and Data Channels



### 5.2.4 Low Speed Mode-Bus Turn Around

Lower Power Mode and its State Periods are illustrated for reference purposes on the Bus Turnaround (BTA) from the MCU to the Display Module (ILI2882N) sequence below.

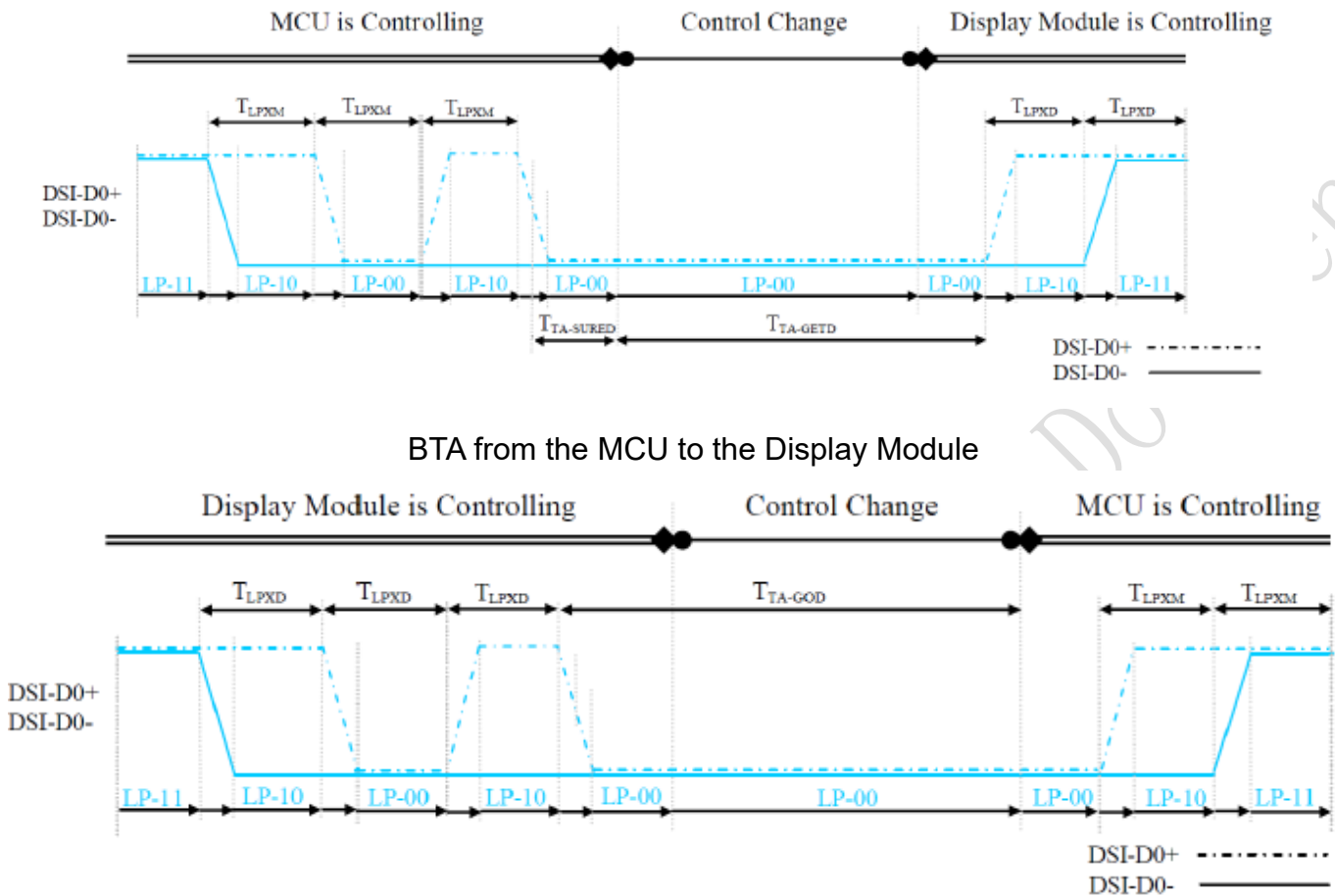

### BTA from the Display Module to the MCU

Signal	Symbol	Description	Min	Max	Unit
DSI-D0+/-	$T_{LPXM}$	Length of LP-00, LP-01, LP-10 or LP-11 periods MCU → Display Module (ILI2882N)	50	75	ns
DSI-D0+/-	$T_{LPXD}$	Length of LP-00, LP-01, LP-10 or LP-11 periods Display Module (ILI2882N) → MCU	50	75	ns
DSI-D0+/-	$T_{TA-SURED}$	Time-out before the Display Module (ILI2882N) starts driving	$T_{LPXD}$	$2 * T_{LPXD}$	ns

### Low Power State Period Timings-A

Signal	Symbol	Description	Time	Unit
DSI-D0+/-	$T_{TA-GETD}$	Time to drive LP-00 by Display Module (ILI2882N)	$5 * T_{LPXD}$	ns
DSI-D0+/-	$T_{TA-GOOD}$	Time to drive LP-00 after turnaround request – MCU	$4 * T_{LPXD}$	ns

### Low Power State Period Timings-B

### 5.2.5 Data Lanes from Low Power Mode to High Speed Mode

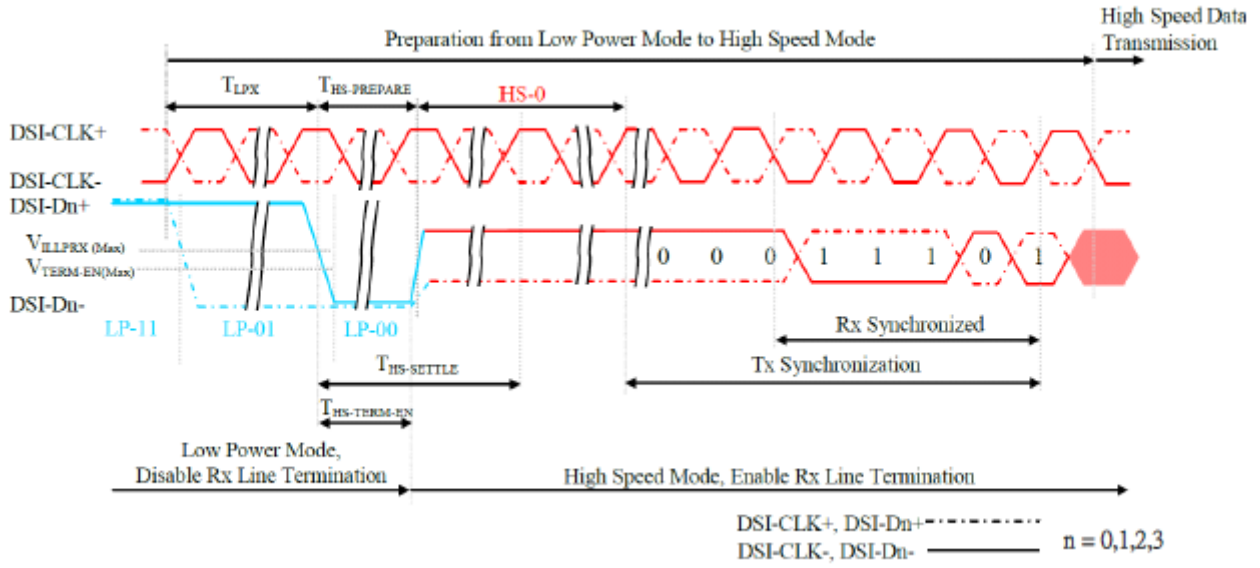

Data Lanes-Low Power Mode to High Speed Mode Timings

Signal	Symbol	Description	Min	Max	Unit
DSI-Dn+/- (n=0,1,2,3)	$T_{LPX}$	Length of any Low Power State Period	50	-	ns
DSI-Dn+/- (n=0,1,2,3)	$T_{HS-PREPARE}$	Time to drive LP-00 to prepare for HS Transmission	$40+4xUI$	$85+6xUI$	ns
DSI-Dn+/- (n=0,1,2,3)	$T_{HS-TERM-EN}$	Time to enable Data Lane Receiver line termination measured from when Dn crosses VILMAX	-	$35+4xUI$	ns

Data Lanes-Low Power Mode to High Speed Mode Timings

### 5.2.6 Data Lanes from High Speed Mode to Low Power Mode

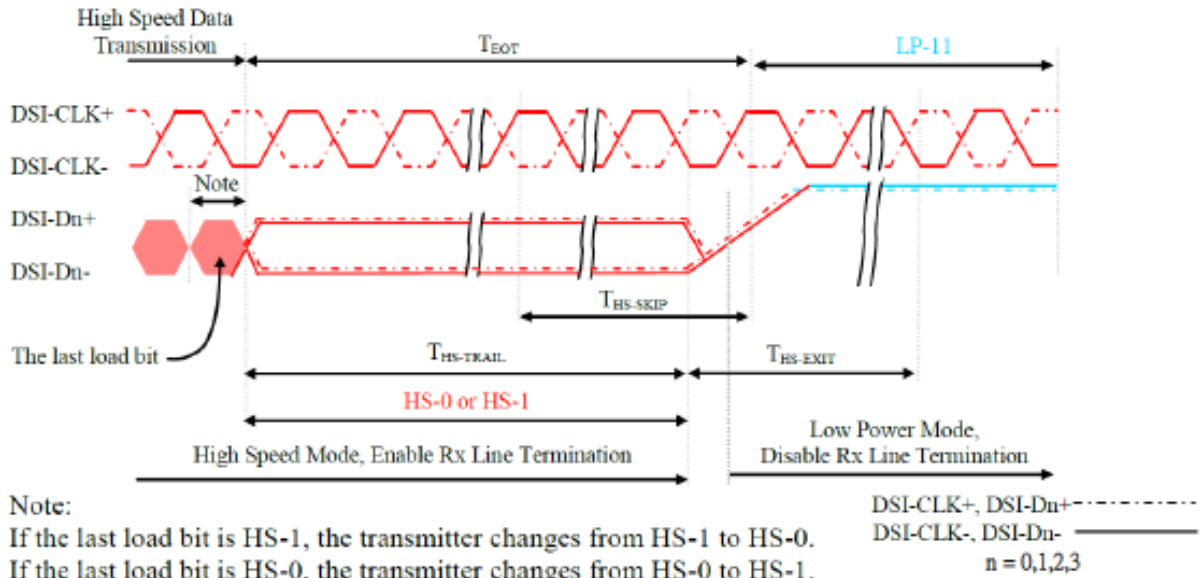

Data Lanes-High Speed Mode to Low Power Mode Timings

Signal	Symbol	Description	Min	Max	Unit
DSI-Dn+/- (n=0,1,2,3)	$T_{HS-SKIP}$	Time-Out at Display Module (ILI2882N) to ignore transition period of EoT	40	$55+4xUI$	ns
DSI-Dn+/- (n=0,1,2,3)	$T_{HS-EXIT}$	Time to driver LP-11 after HS burst	100	-	ns
DSI-Dn+/- (n=0,1,2,3)	$T_{HS-TRAIL}$	Time that the transmitter drives the flipped differential state after last payload data bit of a HS transmission burst	$\max(8*UI, 60ns+ 4*UI)$	-	ns

Data Lanes-High Speed Mode to Low Power Mode Timings

### 5.2.7 DSI Clock Burst-High Speed Mode to/from Low Power Mode

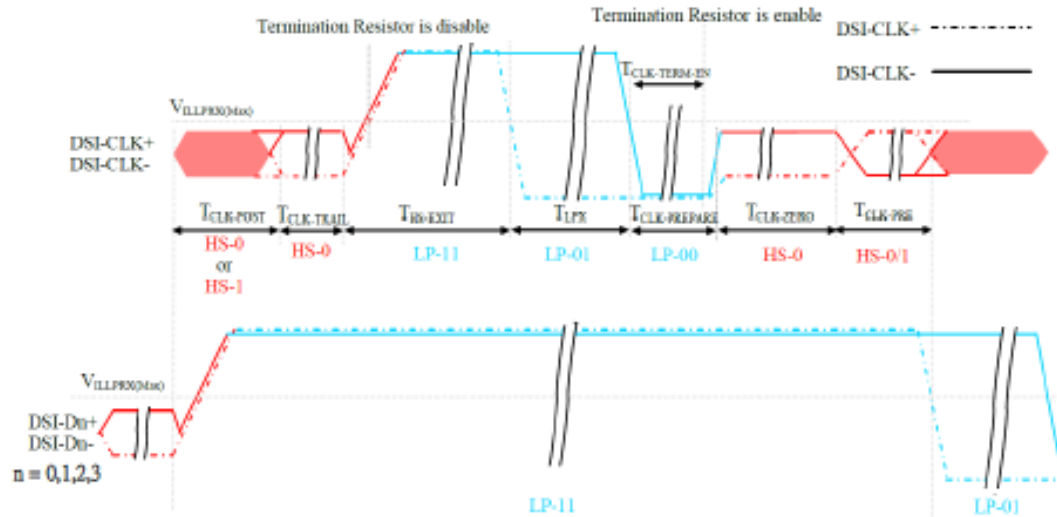

Clock Lanes-High Speed Mode to/from Low Power Mode Timings

Signal	Symbol	Description	Min	Max	Unit
DSI-CLK+/-	$T_{CLK-POST}$	Time that the MCU shall continue sending HS clock after the last associated Data Lanes has transitioned to LP mode	$60+52xUI$	-	ns
DSI-CLK+/-	$T_{CLK-TRAIL}$	Time to drive HS differential state after last payload clock bit of a HS transmission burst	60	-	ns
DSI-CLK+/-	$T_{HS-EXIT}$	Time to drive LP-11 after HS burst	100	-	ns
DSI-CLK+/-	$T_{CLK-PREPARE}$	Time to drive LP-00 to prepare for HS transmission	38	95	ns
DSI-CLK+/-	$T_{CLK-TERMIN}$	Time-out at Clock Lane to enable HS termination	-	38	ns
DSI-CLK+/-	$T_{CLK-PREPARE}$	Minimum lead HS-0 drive period before starting Clock	300	-	ns
DSI-CLK+/-	$T_{CLK-PRE}$	Time that the HS clock shall be driven prior to any associated Data Lane beginning the transition from LP to HS mode	$8xUI$	-	ns

Clock Lanes-High Speed Mode to/from Low Power Mode Timings

## 5.2.8 Timing for DSI Video Mode

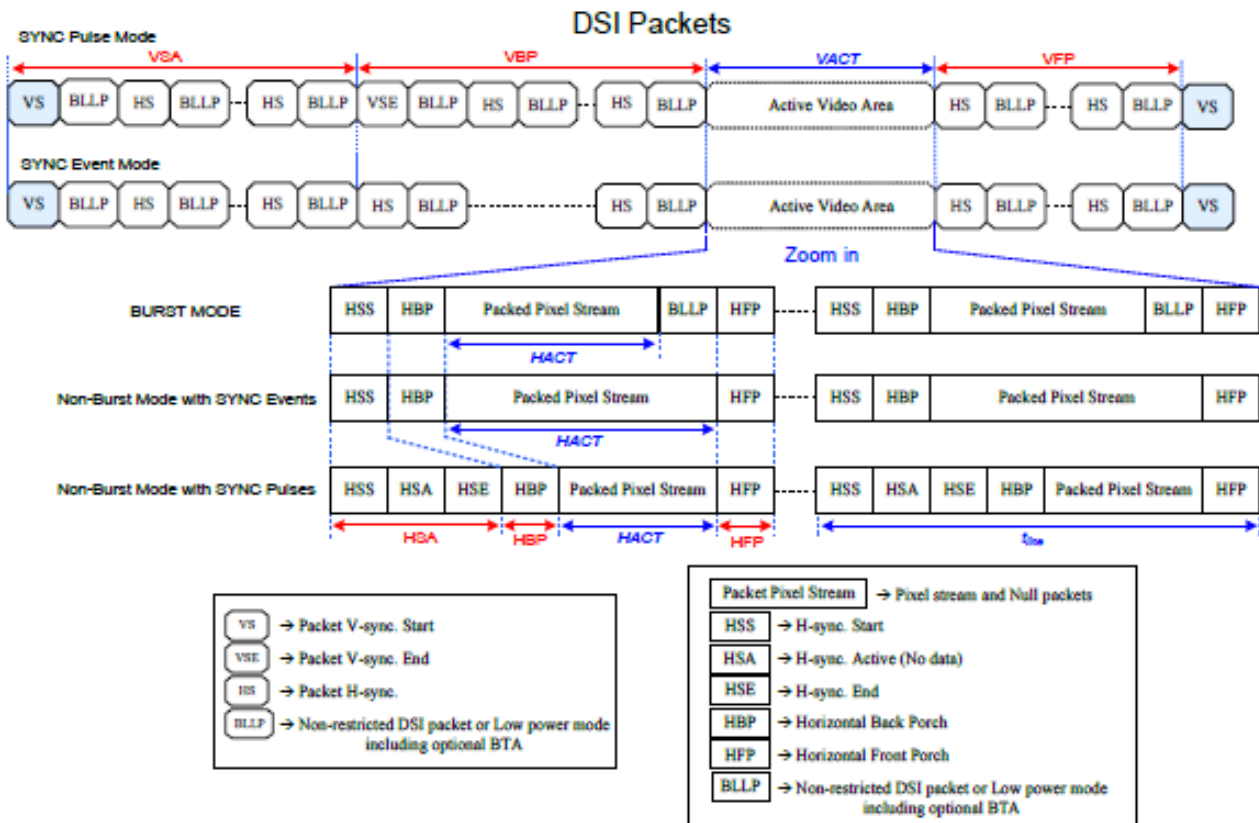

Parameters	Symbols	Min.	Typ.	Max.	Units
Vertical sync. active	VSA <sup>Note 6, 7</sup>	2	-	-	Line
Vertical Back Porch	VBP <sup>Note 6, 7</sup>	16	-	-	Line
Vertical Front Porch	VFP <sup>Note 6, 7</sup>	20	-	-	Line
Active lines per frame	VACT	-	1280	-	Line
Horizontal sync. active	HSA	2	-	-	Pixel
Horizontal Porch	HSA + HBP + HFP	0.5	-	-	us
Active pixels per line	HACT	-	720	-	Pixel
Bit Rate	BRbps	-	-	Note 5	Mbps/lane

1 UI = 1/Bit rate

$HAS(\text{pixel}) = (tHSA \times \text{lane number}) / (UI \times \text{pixel format})$

$HBP(\text{pixel}) = (tHBP \times \text{lane number}) / (UI \times \text{pixel format})$

$HFP(\text{pixel}) = (tHFP \times \text{lane number}) / (UI \times \text{pixel format})$

$$\text{Frame Rate} = \frac{BR_{\text{bps}} \times \text{Lane}_{\text{num}}}{(VACT + VSA + VBP + VFP) \times (HACT + HSA + HBP + HFP) \times \text{Pixel Format}}$$

Example :  $BR_{\text{bps}} = 880\text{Mbps/lane}$ ,  $1UI = 1.13\text{ns}$ ,  $\text{Frame rate} = 60.2\text{Hz}$ ,  $VACT = 1280$ ,  $VSA = 4$ ,  $VBP = 4$ ,  $VFP = 4$ ,  $HACT = 720$ ,  $HSA = 20$ ,  $HBP = 70$ ,  $HFP = 90$ ,  $\text{Lane}_{\text{num}} = 4(\text{lane})$ ,  $\text{Pixel Format} = 24(\text{bit})$ .

### 5.3 Reset Timings

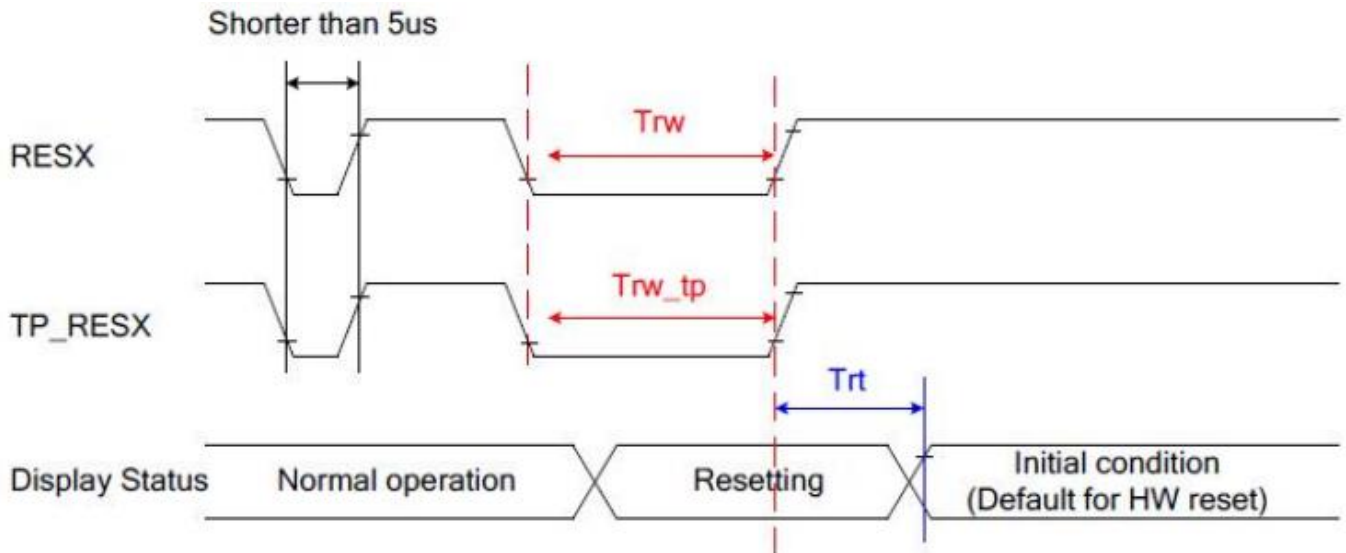

Signal	Symbol	Parameter	Min	Max	Unit
RESX	$T_{rw}$	Reset pulse duration	10	-	us
	$T_{rt}$	Reset cancel	35 <small>(Note 1,5)</small>	-	ms
			150 <small>(Note 1,6,7)</small>	-	ms
TP_RESX	$T_{rw\_tp}$	Reset pulse duration	1	-	us

## 6 Optical Characteristics

Item	Symbol	Condition	Min.	Typ.	Max.	Unit	Remark
Viewing Angle	Top	$CR \geq 10$	-	85	-	Deg.	Note 2
	Bottom		-	85	-		
	Left		-	85	-		
	Right		-	85	-		
Contrast Ratio	CR	$\theta=0^\circ$	1000	1200	-		
Response Time	$T_r+T_d$	$\theta=0^\circ$	-	35	45	ms	
Color Chromaticity (CIE1931)	Wx		0.229	0.279	0.329		
	Wy		0.245	0.295	0.345		
	Rx		0.568	0.618	0.668		
	Ry		0.275	0.325	0.375		
	Gx		0.264	0.314	0.364		
	Gy		0.558	0.608	0.658		
	Bx		0.099	0.149	0.199		
	By		0.007	0.057	0.107		
Color Gamut	NTSC		65	70	-	%	

Test conditions:

IF= 80 mA, and the ambient temperature is 25°C.

**Note 1: Definition of optical measurement system.**

The optical characteristics should be measured in dark room. After 5 minutes operation, the optical properties are measured at the center point of LCD.

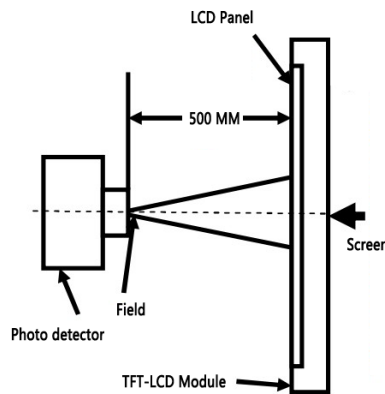

**Note 2: Definition of viewing angle range and measurement system.**

The viewing angle is measured at the center point of the LCD by BM-7A.

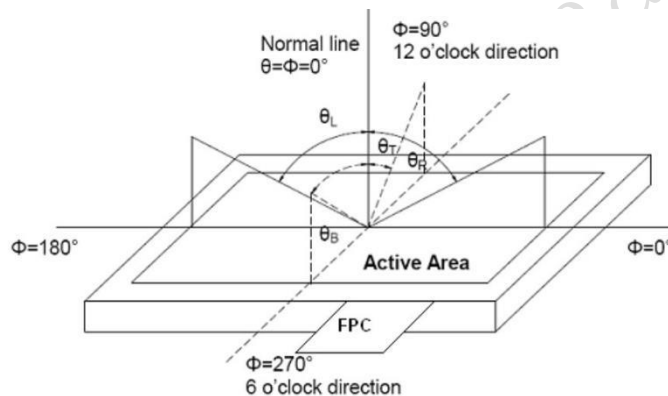

**Note 3: Definition of color temperature.**

When the radiation of the light source is exactly the same in the visible region and the absolute blackbody, the temperature of the blackbody is called the color temperature of the light source. Color temperature is an index to measure the degree of light source color (cold color, warm color). Warm color < 3300K, intermediate color 3300 ~ 5000K, cold color > 5000K.

**Note 4: Definition of response time.**

The response time is defined as the LCD optical switching time interval between “White” state and “Black” state. Time ON (TON) is the time between photo detector output intensity changed from 90% to 10%. And time off (TOFF) is the time between photo detector output intensity changed from 10% to 90%.

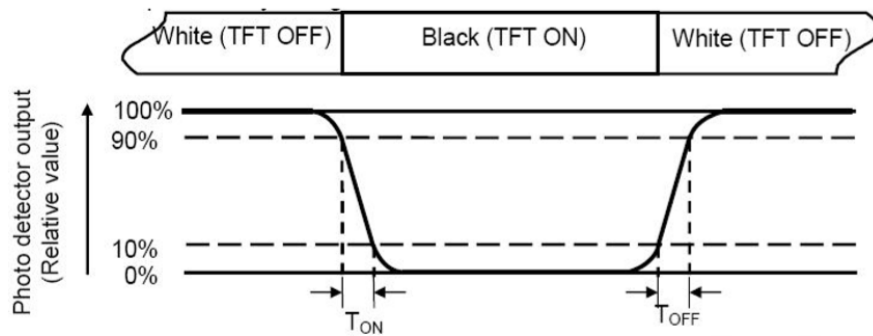

**Note 5: Definition of color chromaticity (CIE1931).**

Color coordinates measured at center point of LCD.

**Note 6: Definition of luminance.**

Measure the luminance of white state at center point.



## 7 Environmental Reliability Test

NO	Test Item	Condition	Remarks
1	High Temperature Operation	Ta=+70℃, 96hours	IEC60068-2-1:2007 GB2423.2-2008
2	Low Temperature Operation	Ta=-20℃, 96hours	IEC60068-2-1:2007 GB2423.1-2008
3	High Temperature Storage	Ta=+80℃, 96hours	IEC60068-2-1:2007 GB2423.2-2008
4	Low Temperature Storage	Ta=-30℃, 96hours	IEC60068-2-1:2007 GB2423.1-2008
5	Storage at High Temperature and Humidity	Ta=+40℃, 90% RH,96hours	IEC60068-2-78 :2001 GB/T2423.3-2006
6	Thermal Shock (non-operation)	-30℃,30min~80℃,30min,change time: 5min,100cycle	Start with cold temperature, End with high temperature, IEC60068-2-14:1984, GB 2423.22-2002
7	ESD(non-operation)	C=150pF,R=330Ω,5point/panel Air:±8kv,5times; Contact:±4kv,5times; ( Environment:15℃~35℃,30%~60%, 86Kpa~106Kpa )	IEC61000-4-2:2001 GB/T 17626.2-2006
8	Vibration Test	5-20-200HZ,PSD:0.01-0.01-0.001 Total:0.781g2/HZ,x/y/z every direction 30min	IEC60068-2-6:1982 GB/T 2423.10-1995
9	Package Drop Test	Height: 60cm,1 corner, 3edges, 6 surfaces	IEC60068-2-32:1990 GB/T 2423.8—1995

## 8 Packing Capacity & Dimension

Dimension			
Dimension(mm)	77.98(W)*82.00(H)*2.13(D)		
Net Weight	27g		
Packing Capacity			
Size	LCD Size and Resolution	Layer	Quantity(Pcs)
220mm(L)x160mm(W)x47mm(H)	4.12 inch 720*720	1	1
600mm(L)x450mm(W)x300mm(H)	4.12 inch 720*720	2	240

Packing instruction:

The LCD is placed in the grid, covered with a PE static bag and compactly assembled, the upper and the lower layers of the grid are protected by buffer spaces.

The LCD covered with a PE static bag and compactly assembled



placed in the grid



The upper and the lower layers of the grid are protected by buffer spaces



Packed



## 9 Appearance Inspection

### 9.1 General rules for inspection

9.1.1 Anti-static wearables (anti-static wristbands, gloves) must be worn during the inspection.

9.1.2 Do not use bare hands to touch the position of the device, golden fingers, and the surface of the screen to prevent the sweat from human hands from causing oxidation and affecting the appearance.

9.1.3 It is forbidden to stack products out of specification and handle them with care to avoid damage to components.

9.1.4 The repaired products need to be inspected to prevent rosin and tin slag from exceeding the specifications.

9.1.5 When technical documents and process documents have specific requirements for products, the technical documents and process documents shall be the main requirements.

### 9.2 Inspection conditions

9.2.1 The conditions of display function check

Angle:  $\pm 5^\circ$ ;

Inspection method: visual inspection. The inspection object is 30-40cm away from the light source, and the eye is 30-40cm away from the inspection object;

Illumination: 300-500Lux;

Inspection time: 5-10S.

9.2.2 Visual inspection conditions

Angle:  $\pm 45^\circ$ ;

Inspection method: visual inspection. The inspection object is 30-40cm away from the light source, and the eye is 30-40cm away from the inspection object;

Illumination: 800-1500Lux;

Inspection time: 5-10S.

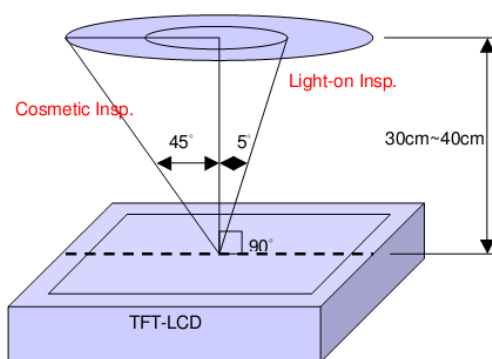

## 9.3 Inspection standards

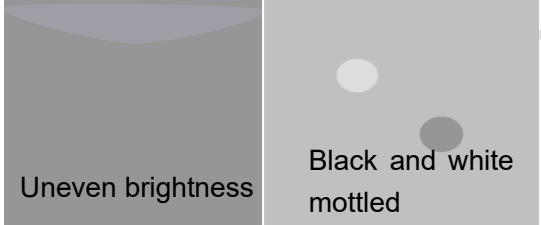
Type	Test Items	Judgement Standard	Defect Category
Display state	Dead pixels	No dead pixels	
	mura	<p>From different angles, the brightness is required to be uniform.                      Under the 64-level grayscale or pure black interface, there should be no uneven display brightness within the viewing angle range of 45° through 6% ND FILTER.                      Y series (TV film) LCD screen does not have specific requirements, and the picture inspection does not affect the display as qualified.</p> 	Slight defect
	Light leakage	<p>Under the 64-level grayscale or pure black interface, there should be no obvious light leakage within the viewing angle range of 45° by visual inspection or through 6% ND FILTER.                      Y series (TV LCD screen) series can be without obvious visual defects.</p>	Slight defect
	Linear foreign bodies	<p>1. <math>W \leq 0.05</math>, <math>L \leq 2\text{mm}</math>, negligible;                      2. <math>0.05\text{mm} &lt; W \leq 0.1\text{mm}</math>, <math>L \leq 2\text{mm}</math>, <math>N \leq 3</math>;                      3. <math>W &gt; 0.1\text{mm}</math>, <math>L &gt; 2\text{mm}</math>, not allowed.</p>	Slight defect
Screen surface	Within the effective area	<p>Spotted:                      1. <math>D \leq 0.2\text{mm}</math> and it is not a piece, it is not counted;                      2. <math>0.2\text{mm} &lt; D \leq 0.5\text{mm}</math>, <math>N \leq 3</math>;                      3. <math>D &gt; 0.5\text{mm}</math>, <math>L &gt; 0.5\text{mm}</math>, <math>W &gt; 0.5\text{mm}</math> are not allowed;                      (The spotted foreign objects shall not exceed the point-line gauge <math>D=0.5</math>, and the black dot coverage shall be checked, and the spotted foreign objects shall be judged within the range of <math>D=0.5</math>)</p>	Slight defect

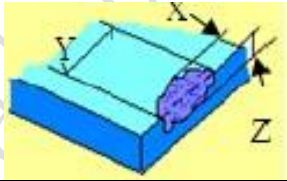
	Foreign objects Scratch Air bubbles	Linear: 1. $W \leq 0.05$ , $L \leq 2\text{mm}$ , ignored; 2. $0.05 < W \leq 0.1\text{mm}$ , $L \leq 2\text{mm}$ , $N \leq 3$ ; 3. $W > 0.1\text{mm}$ , $L > 2\text{mm}$ , not allowed.	
	Outside the effective area Foreign objects Scratches Air bubbles	Foreign objects are not checked, and bubbles are not allowed to $D > 1\text{mm}$ ; Non-inductive scratches of no more than $0.1 \times 8\text{mm}$ are allowed.	Slight defect
	Crack	Not allowed.	 Slight defect
	Notch	1. Does not affect the appearance from the front; 2. Does not affect the relevant alignment; 3. $X \leq 1\text{mm}$ , $Y \leq 1\text{mm}$ , $N \leq 2$ .	 Slight defect
	Glass side Foreign objects Dirty	1. The foreign body on the side is not controlled; 2. The paint pen marks on the side are not controlled; 3. Side oily note printing is not allowed.	Slight defect
FPC	Cracks Goldfinger crease	Not allowed.	Heavy deficit
	Crease	Slight creases are not controlled; The crease is whitish and has lines, which is not allowed.	Heavy deficit
	Top wound, stab wound	No damage to the line, $D \leq 0.2\text{mm}$ ; Damage to the line is not allowed.	Heavy deficit
	Scratch	Slight scratches on the surface are not controlled; Damage to the line is not allowed.	Heavy deficit
	Goldfinger scratch	$W \leq 0.05\text{mm}$ , no control; $W > 0.05\text{mm}$ , not allowed; Test probe tip marks are not controlled.	Heavy deficit
	Component	Under-soldering, over-soldering and false soldering are not allowed.	Heavy deficit

## 10 Precautions for Use of LCD Modules

### 10.1 Handling Precautions

10.1.1 The display panel is made of glass. Do not subject it to a mechanical shock by dropping it from a high place, etc.

10.1.2 If the display panel is damaged and the liquid crystal substance inside it leaks out, be sure not to get any in your mouth, if the substance comes into contact with your skin or clothes, promptly wash it off using soap and water.

10.1.3 Do not apply excessive force to the display surface or the adjoining areas since this may cause the color tone to vary.

10.1.4 The polarizer covering the display surface of the LCD module is soft and easily scratched. Handle this polarizer carefully.

10.1.5 If the display surface is contaminated, breathe on the surface and gently wipe it with a soft dry cloth. If still not completely clear, Can only use LCD dedicated cleaner, the following organic solvent can not be used:

- Isopropyl alcohol
- Ethyl alcohol
- Ketone
- Aromatic solvents

10.1.6 Do not attempt to disassemble the LCD Module.

10.1.7 If the logic circuit power is off, do not apply the input signals.

10.1.8 To prevent destruction of the elements by static electricity, be careful to maintain an

10.1.9 optimum work environment.

10.1.9.1 Be sure to ground the body when handling the LCD Modules.

10.1.9.2 Tools required for assembly, such as soldering irons, must be properly ground.

10.1.9.3 To reduce the amount of static electricity generated, do not conduct assembly and other work under dry conditions.

10.1.9.4 The LCD Module is coated with a film to protect the display surface. Be care when peeling off this protective film since static electricity may be generated.

### 10.2 Storage precautions

10.2.1 When storing the LCD modules, avoid exposure to direct sunlight or to the light of fluorescent lamps.

10.2.2 The LCD modules should be stored under the storage temperature range. If the LCD modules will be stored for a long time, the recommend condition is:

Temperature: 0°C ~ 40°C Relatively humidity: ≤80%.

10.2.3 The LCD modules should be stored in the room without acid, alkali and harmful gas.

### 10.3 Transportation Precautions

10.3.1 The LCD modules should be no falling and violent shocking during transportation, and also should avoid excessive press, water, damp and sunshine.

## 11 LCD Introduction

### 11.1 Process capacity

DWIN adopts original class A glass and the entire production is in the park from cleaning, cutting, bonding, and laminating of large glass to backlight assembly, quality inspection, and aging.

There are 12,000 square meters of clean workshop, with a monthly production capacity of about 2.5 million pieces.



### 11.2 ODM service

Based on LCD products of 1.5~21.5 inches, DWIN provides the following customization services.

1、LCD HDMI interface customization.

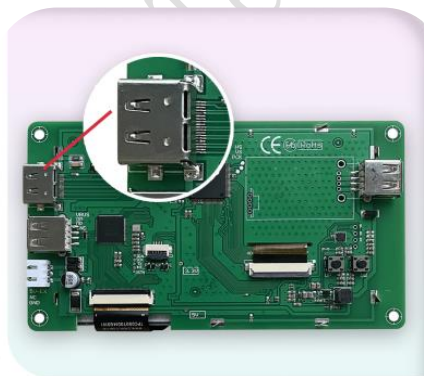

HDMI interface

2、Special screen customization such as high brightness, ultra-wide temperature and strong electromagnetic protection.

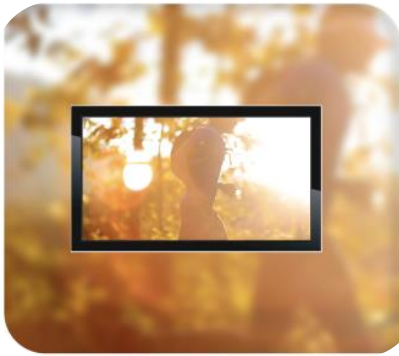

High luminance  
(up to 1200nit)



Ultra-wide temperature  
(-40~85℃)



Strong electromagnetic  
protection

3、Lamination customization service of LCD + TP.



LCM+RTP



LCM+CTP

4、Customization service of DWIN self-developed T5L ASIC+ LCD + TP.





### 5、Smart screen finished product customization.

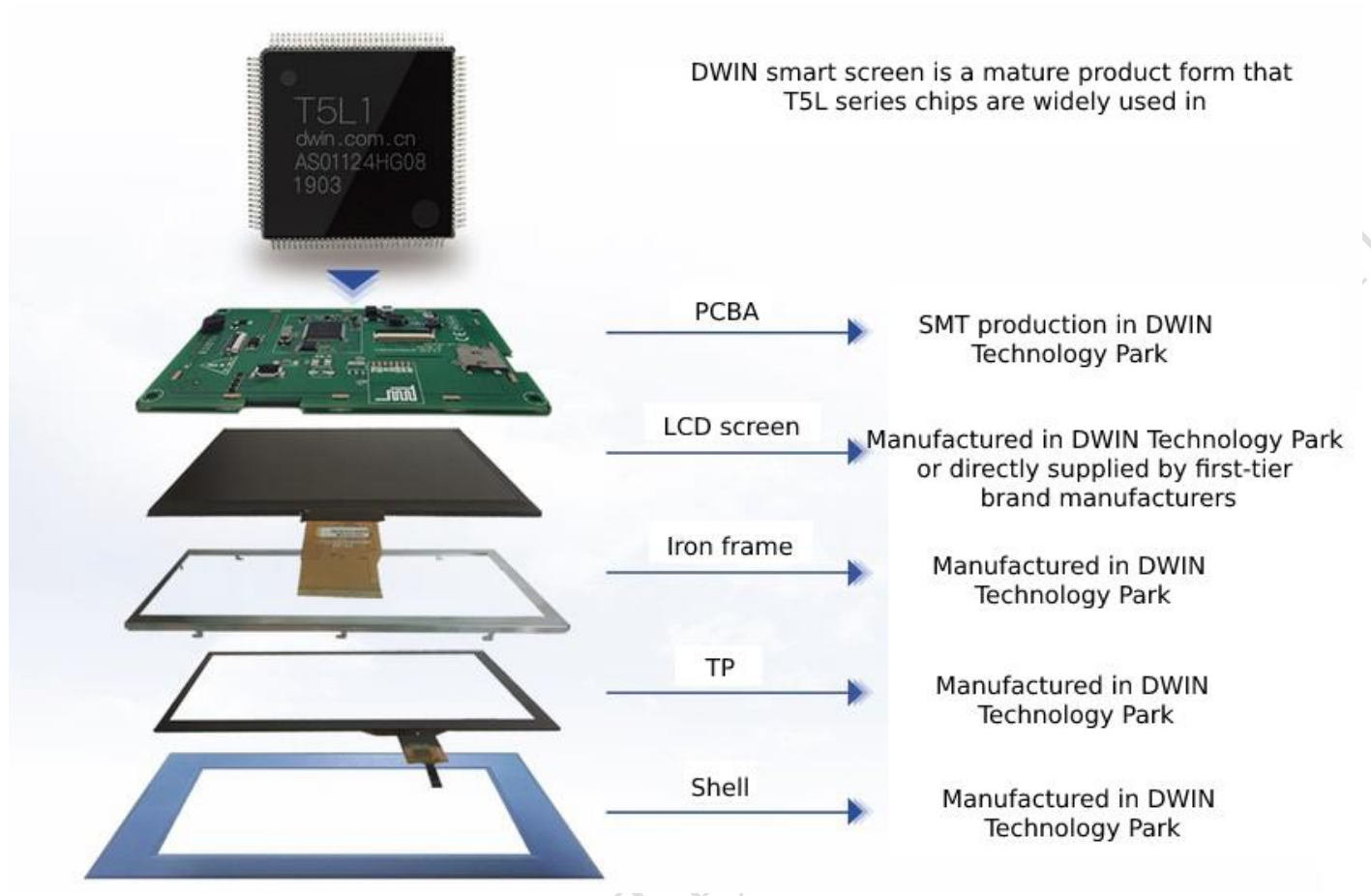

Please contact our sales staff for other customization needs.

## Record of Revision

Rev	Date	Description	Editor
00	2021-12-20	First Release	Ouyang Kaixing
01	2023-02-06	Add Product Picture	Chen Xian
02	2023-02-22	Update Packing Capacity	Chen Xian

Please contact us if you have any questions about the use of this document or our products, or if you would like to know the latest information about our products:

Customer service tel: +86 400 018 9008

Customer service email: [dwinhmi@dwin.com.cn](mailto:dwinhmi@dwin.com.cn)

DWIN developer forum: <https://forums.dwin-global.com/index.php/forums/>

Thank you all for continuous support of DWIN, and your approval is the driving force of our progress!